

MANUAL CU INSTRUCȚIUNI PENTRU

> SAUNA

MODEL:WS-1102

ATENȚIE

1. Va rugam sa consultati acest manual inaintea montajului si inaintea utilizarii saunei.
2. Va recomandam sa folositi un izolant de buna calitate si sa aveti impamantare facuta.
3. Va rugam sa montati un comutator general pentru alimentarea electrica, in conformitate cu legile in vigoare.
4. Utilizatorii hipertensivi si cei in stare de ebrietate ar trebui sa NU foloseasca acest produs!
5. Copiii trebuie sa fie sub supravegherea unui adult de fiecare data cand intrebuinteaza sauna.
6. Nu folositi lichide corozive in interiorul saunei.
7. Nu folositi sauna pentru o perioada foarte lunga de timp. Teava se poate supraincalzi dupa o perioada atat de lunga.
8. Compania noastra nu-si asuma nicio responsabilitate pentru folosirea necorespunzatoare a saunei sau a nerespectarii acestor reguli elementare.
9. Cand doriti sa aruncati produsul la gunoi, va rugam sa folositi recipientele adecvate in conformitate cu legea din tara dvs.

TECHNICAL PARAMETERS

1. Voltaj nominal AC 220V ± 10% 50Hz/60Hz
2. Putere incalzitor: 3000W
3. 2000X2200X2100mm
2000X1700X2100mm
1800X1500X2100mm

PANOUL DE CONTROL

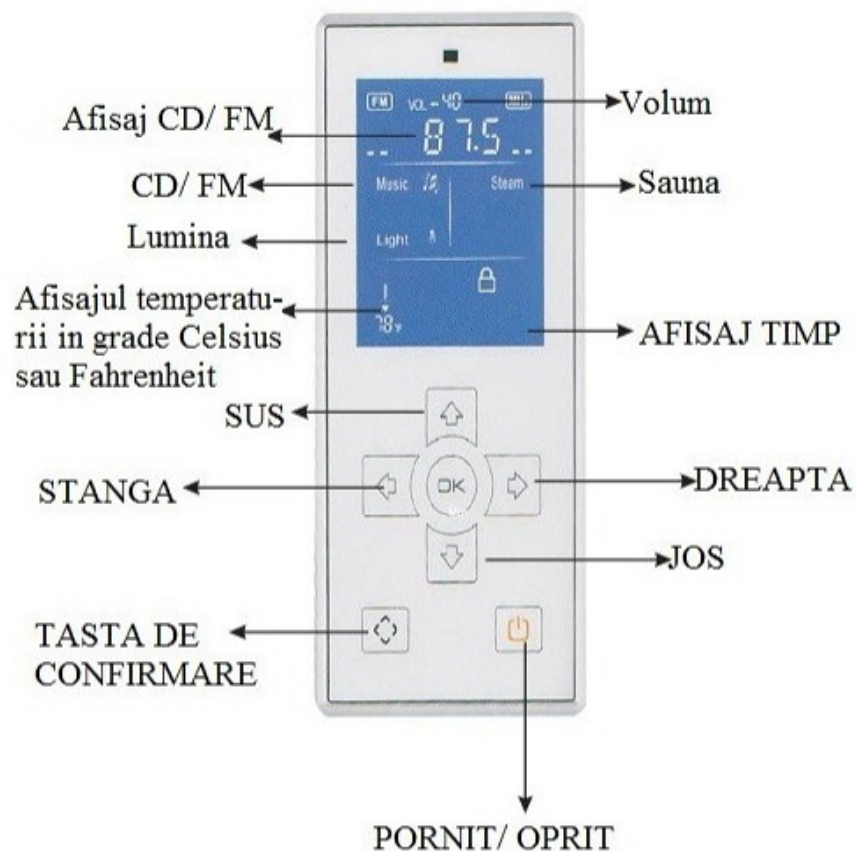

— **Functiile saunei**

1. Incalzitor
2. Lumina
- 3 CD
5. Functia temperaturii, grade Celsius/Fahrenheit



二、**Descrierea functiilor**

1、PORNIT/ OPRIT

Pentru pornirea sistemului, se apasa: . Pe ecran apare temperatura si durata functiei.

Se apasa aceeasi tasta pentru inchiderea sistemului.

2、CD



Avand sistemul pornit, se apasa  de pe panou, se muta cursorul pe tasta: . Apasa:  si va porni CD player-ul, apasa o a doua oara pentru radio FM si o a treia oara pentru a le inchide pe toate.

3、LUMINA

Avand sistemul pornit, apasa pe: , apoi comuta pe tasta: 

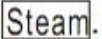

dupa care lumina se aprinde. Apasa pe tasta:  pentru a o stinge.

4、SAUNA

Cu sistemul pornit, se apasa pe:  de pe panou, apoi comutati pana la tasta: . Apasa:  pentru a porni functia de sauna.

La apasarea tastei:  inca o data, functia saunei se opreste.

5、TEMPERATURA

Avand sistemul pornit, se apasa pe:  de pe panou, se comuta apoi pe:  astfel se intra in modul de setare a temperaturii de incalzire, se apasa:  pentru a creste sau a scadea temperatura

Temperatura minima care poate fi setata este de 15 grade iar cea maxima e de 90. Temperatura implicita este de 32 grade.

Se apasa pe tasta:  din nou si sistemul comuta in mod automat intre Celsius si Fahrenheit.

6. BLOCAREA TASTELOR

Atunci cand sistemul este in modul stand-by, tastele sunt in mod automat blocate.

Se apasa pe:  pentru cateva secunde si sistemul va avea tastele deblocate.

SCHITA

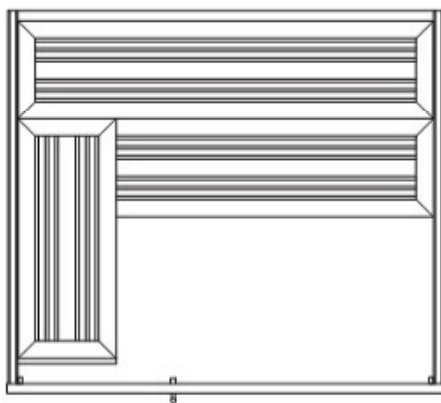
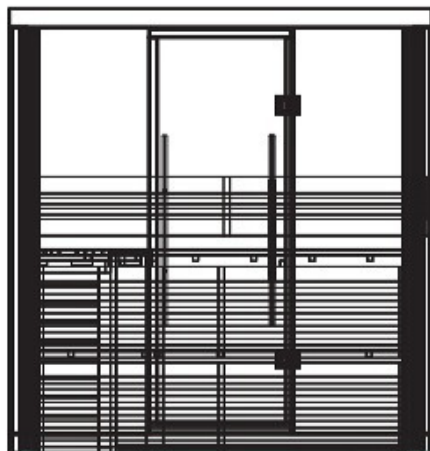

1000X1050X1900mm

PARTI COMPONENTE

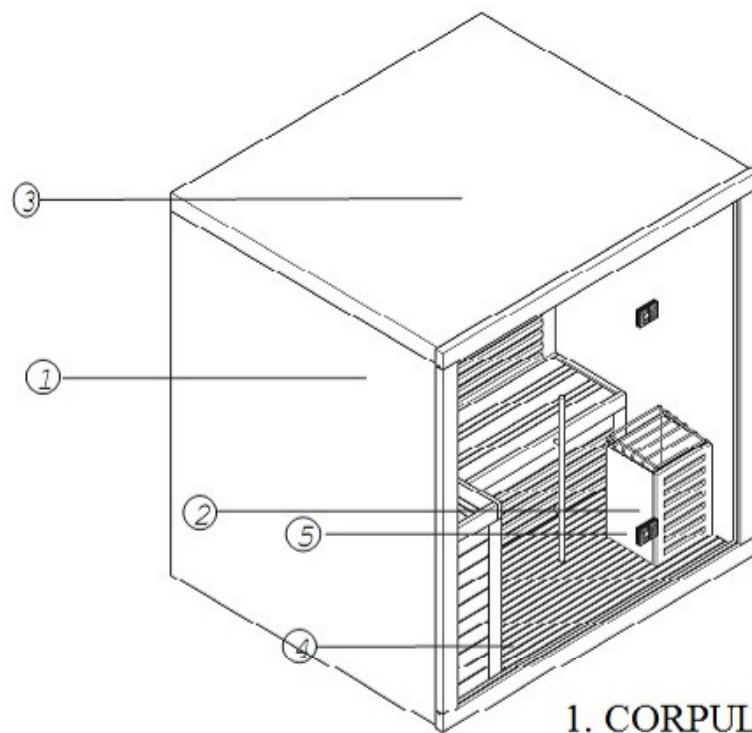

1. CORPUL SAUNEI
2. INCALZITORUL
3. PARTEA DE SUS
4. STICLA
5. BALAMA

PARTI COMPONENTE



DIAGRAMA INSTALARII

SURUB DE $\Phi 6 \times 80 \text{MM}$

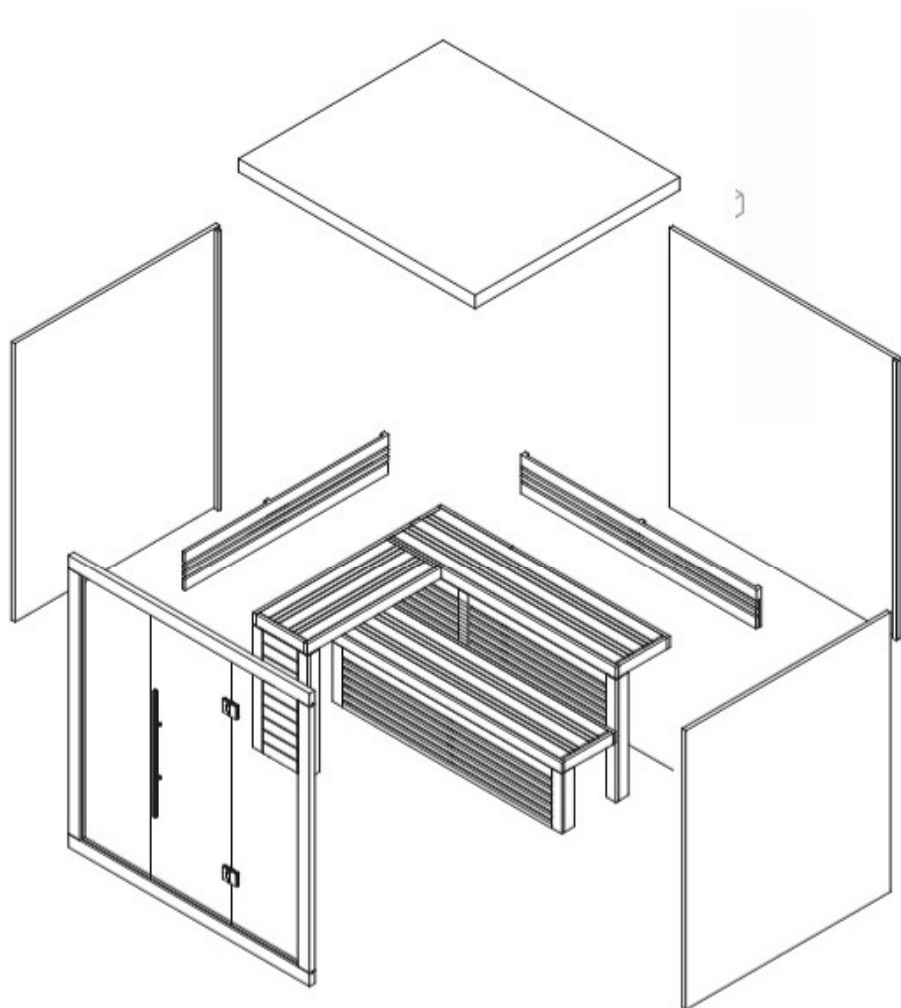
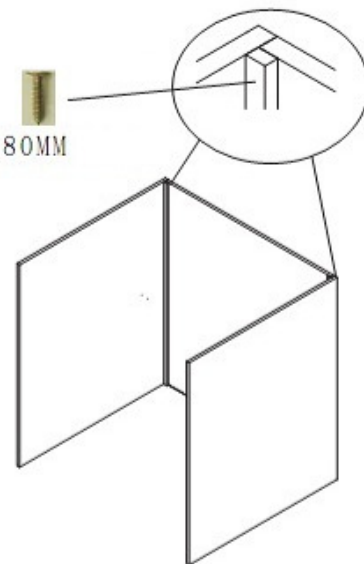

1. IMBINATI PARTILE
LATERALE CU BAZA

4. MONTATI
BANCUTA
INAUNTRUL SAUNEI

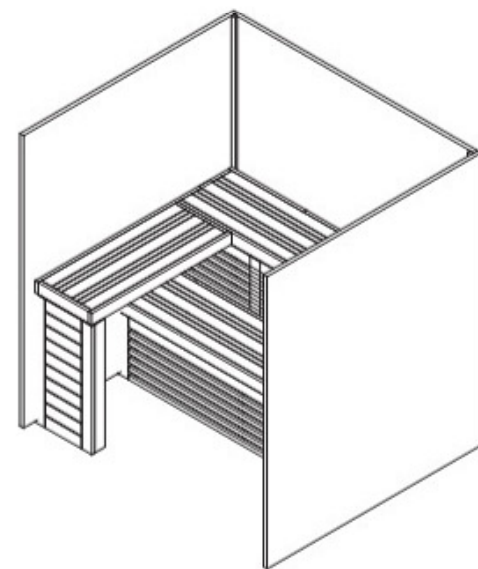

SCHITA

3. Imbinati partea
din fata cu laterala

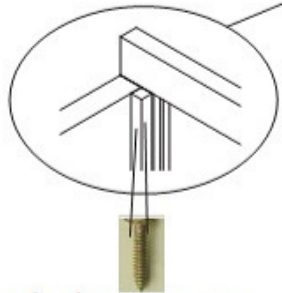

Surub de: $\Phi 6 \times 80 \text{MM}$

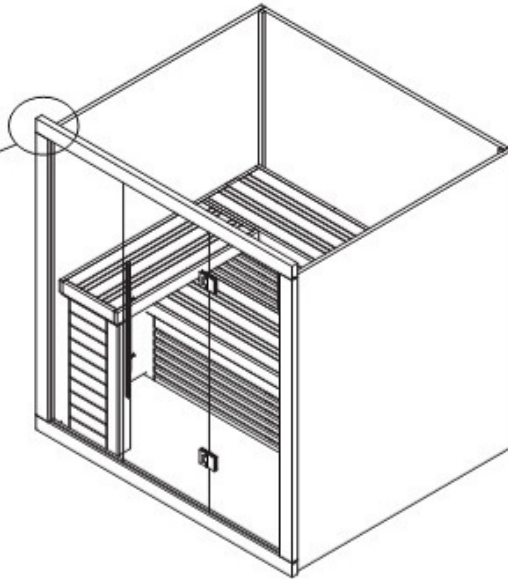

4. Montati tavanul

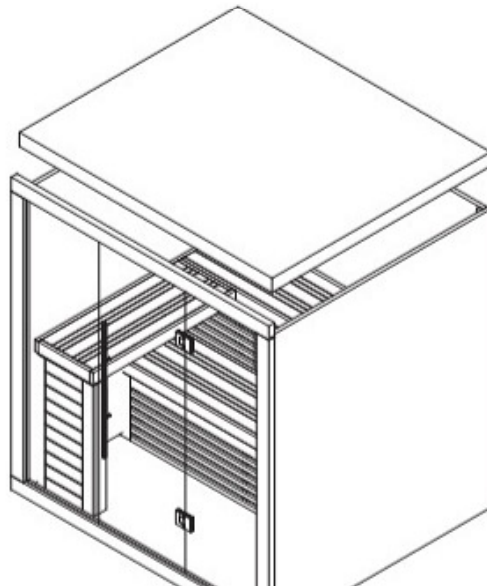

PARTI COMPONENTE

6. Terminarea asamblarii

